

Article number: 12347000040500
Description: KLEE-coil 347 000 040.500
M 4 St. steel 1.4305

Measures

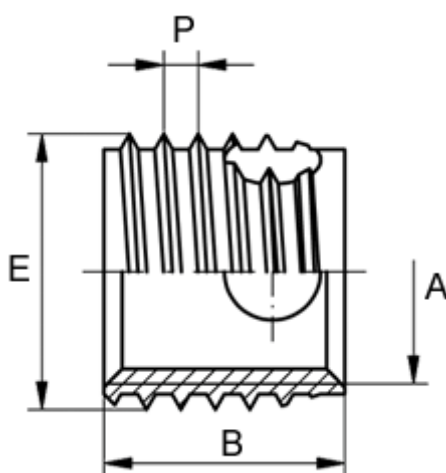

Female thread A	= M4
Length B	= 6
Male thread E	= 6.0
Min hole depth blind hole	= 8
Pre-drilled max	= 5.7
Pre-drilled min	= 5.6
Thread pitch P	= 0.70
Type	= 347 000 040 ...